

M01

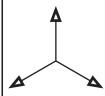

100/40/194

M02

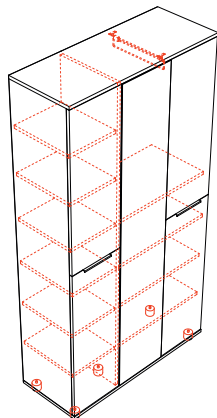
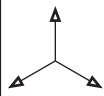
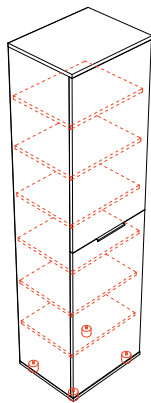

50/40/194

M03

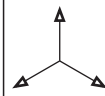
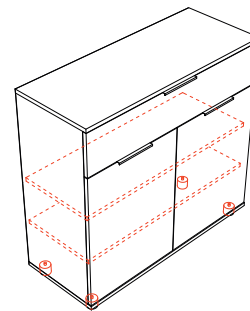

100/40/94

M04

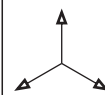
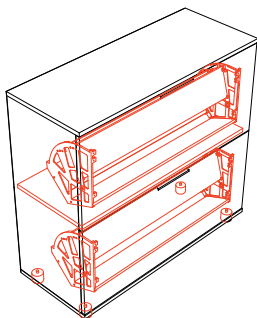

100/40/94

M05

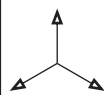
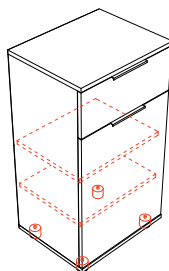

50/40/94

M06

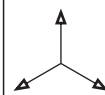
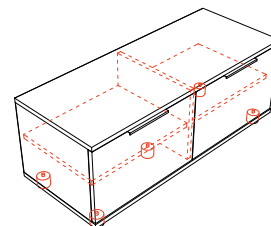

100/40/39

M07

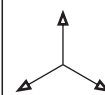
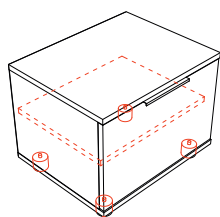

50/40/39

M08

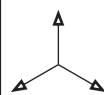
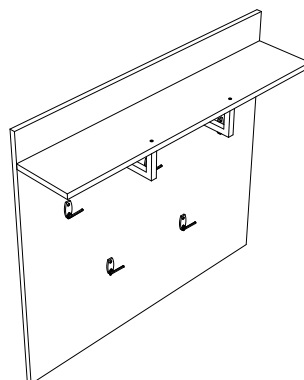

100/22/90

M09

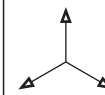
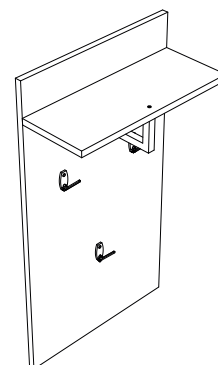

50/22/90

M10

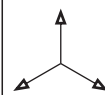
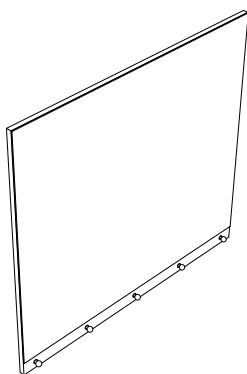

100/2/90

M11

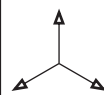
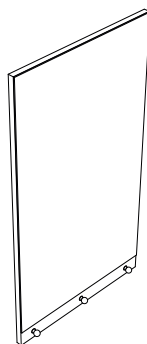

50/2/90

M12

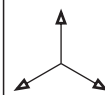
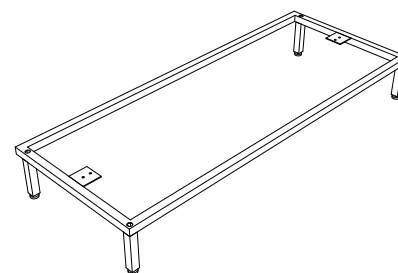

100/40/13

M13

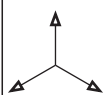
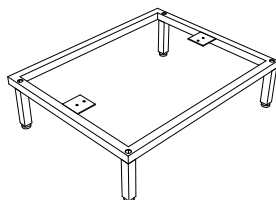

50/40/13

M14

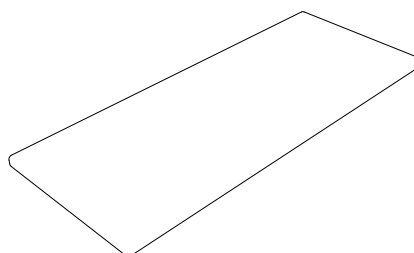

100/40/3

M15

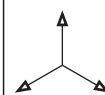
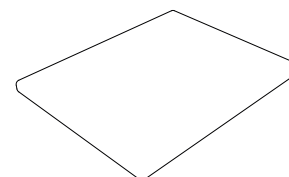

50/40/3